

# **HONDA GENERATOR**

# **EV4000**

## **OWNER'S MANUAL**

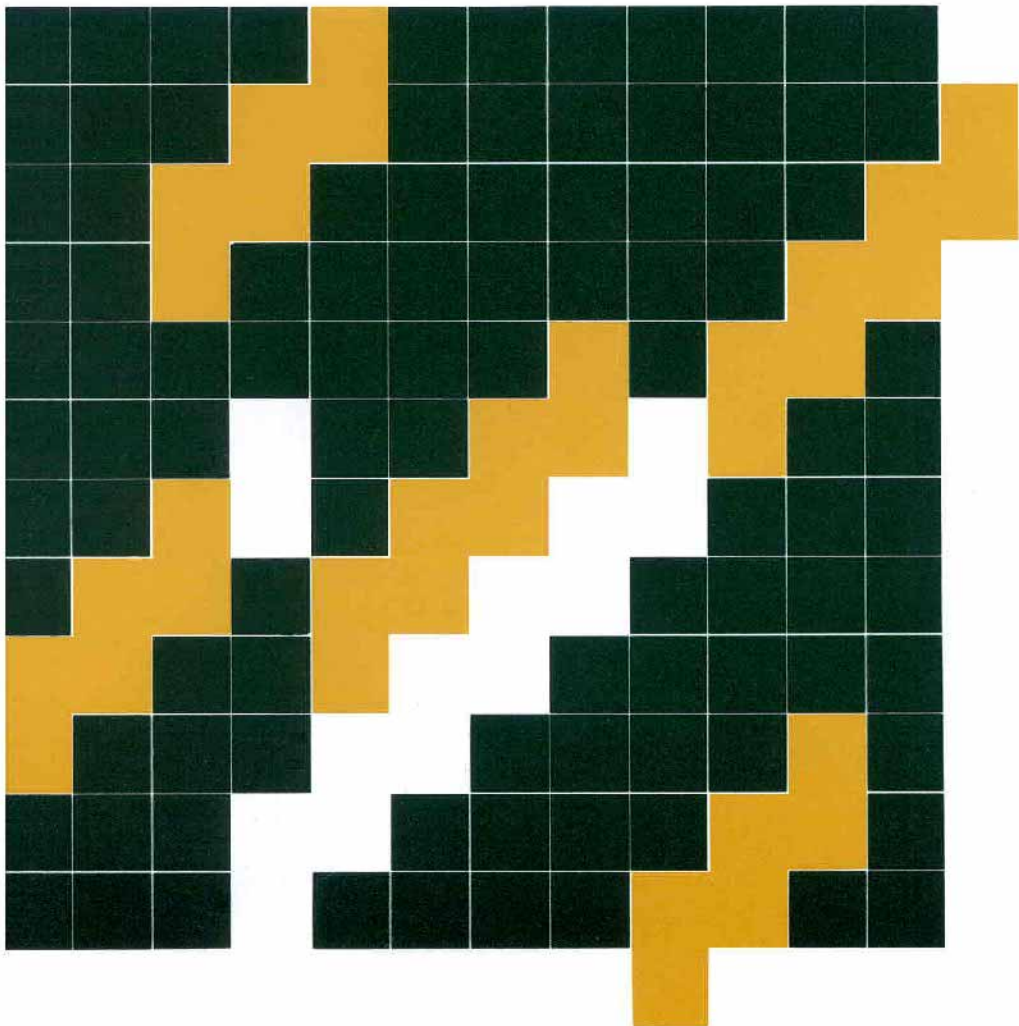

---

Thank you for purchasing a Honda generator.

This manual covers operation and maintenance of the EV4000 generator. All information in this publication is based on the latest product information available at the time of approval for printing.

Honda Motor Co., Ltd. reserves the right to make changes at any time without notice and without incurring any obligation.

No part of this publication may be reproduced without written permission.

This manual should be considered a permanent part of the generator and remain with the generator when sold.

Pay special attention to statements preceded by the following words:

**WARNING** Indicates a strong possibility of severe personal injury or loss of life if instructions are not followed.

**CAUTION:** Indicates a possibility of personal injury or equipment damage if instructions are not followed.

**NOTE:** Gives helpful information.

If a problem should arise, or if you have any questions about the generator, consult an authorized Honda dealer.

**WARNING** The Honda generator is designed to give safe and dependable service if operated according to instructions. Read and understand the Owner's Manual before operating the generator. Failure to do so could result in personal injury or equipment damage.

# CONTENTS

---

1. GENERATOR SAFETY .....	1
2. COMPONENT IDENTIFICATION .....	2
3. PRE-OPERATION CHECK .....	5
4. STARTING AND STOPPING THE ENGINE .....	8
5. GENERATOR USE .....	9
6. MAINTENANCE .....	10
7. EXTENDED STORAGE .....	17
8. TROUBLESHOOTING .....	18
9. SPECIFICATIONS .....	19
10. WIRING DIAGRAM .....	20
11. MAINTENANCE RECORD .....	21

# 1. GENERATOR SAFETY

---

## **Warning**

To ensure safe operation --

- Do not connect the generator to a household circuit. This could cause damage to the generator or to electrical appliances in the house.
- Know how to stop the generator quickly and understand operation of all the controls. Never permit anyone to operate the generator without proper instruction.
- Keep children and pets away from the generator while it is in operation.
- The generator is a potential source of electrical shock when misused: do not operate with wet hands.

## 2. COMPONENT IDENTIFICATION

---

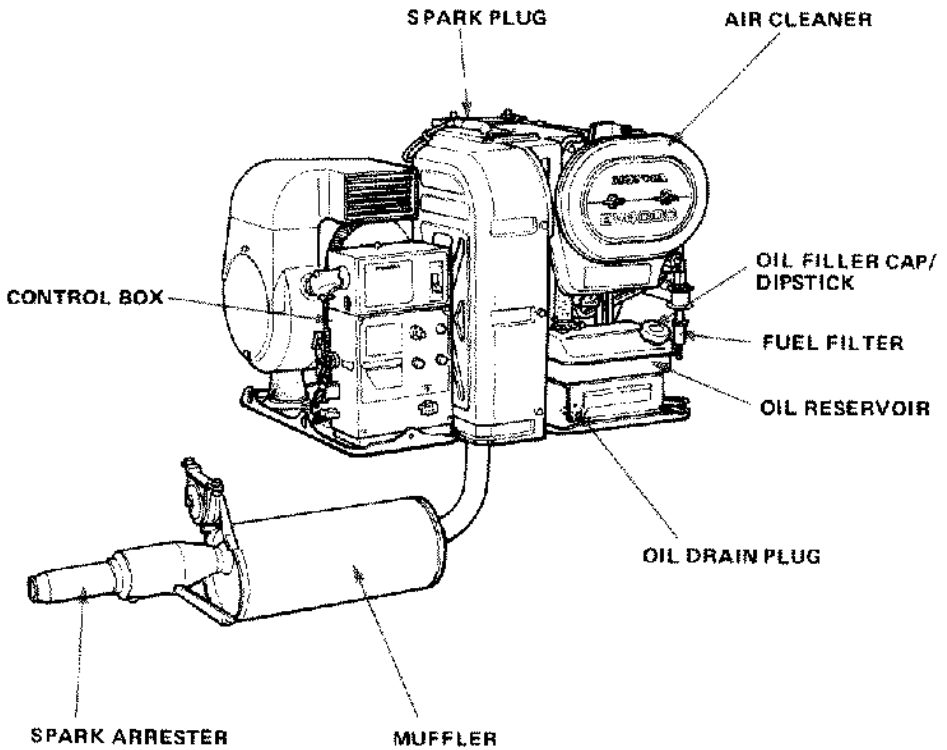

---

## CONTROL BOX

- Circuit breaker:** Switch ON for AC power. The breaker will automatically switch OFF if the circuit is 20% overloaded.
- Pilot lamp:** Lights when the engine is running and goes off when the engine is stopped.
- Battery terminal:** Connect the battery positive (+) cable here.
- Ground terminal:** Connect the battery negative (-) cable here.
- Engine switch:** Starts and stops the generator.
- Fuse holders:** Each holder has a 3 amp fuse.
- Remote control coupler:** The remote control panel coupler is connected here.

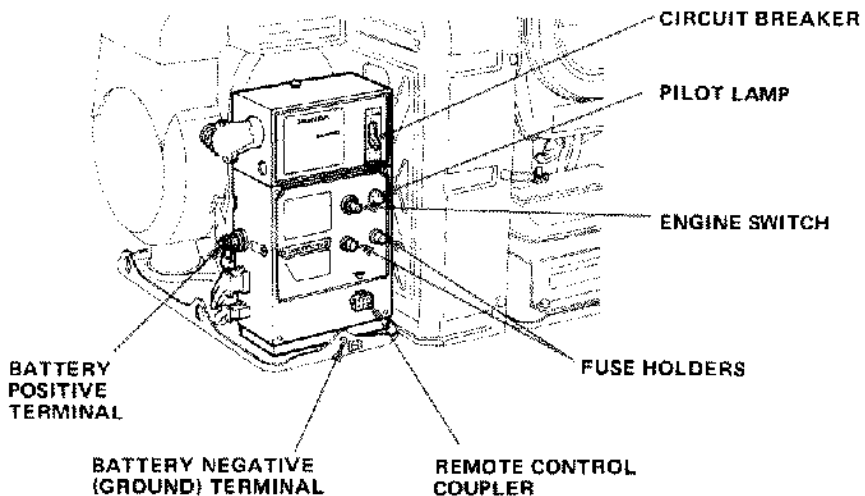

---

## REMOTE CONTROL PANEL

- Engine switch:** Starts and stops the generator.
- Pilot lamp:** Comes on when the engine is running and goes off when the engine is stopped.
- Hour meter:** The numbers on the hour meter indicate the total hours operated. This is your guide for determining when maintenance is due.
- Oil alert buzzer:** Sounds when the engine oil level becomes lower than the specified level. When cranking the engine, the buzzer may sound momentarily, but this is normal.

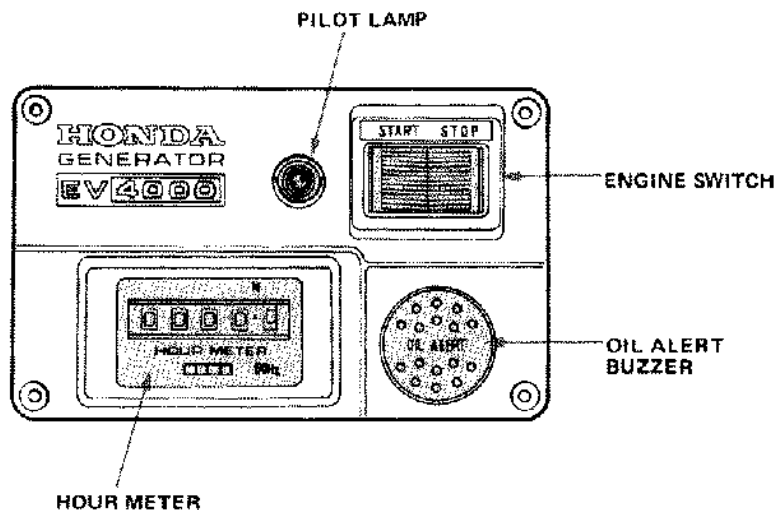

### 3. PRE-OPERATION CHECK

**CAUTION:** Be sure to check the generator while parked on a level surface with the generator engine stopped.

1. Check the engine oil level.

**CAUTION:** Engine oil is major factor affecting engine performance and service life. Non-detergent or vegetable oils are not recommended.

Use Honda 4-stroke oil, or an equivalent high detergent, premium quality motor oil certified to meet or exceed U.S. automobile manufacturer's requirements for Service Classification SE or SF. (Motor oils classified SE or SF will show this designation on the container.)

SAE 10W-40 is recommended for general, all-temperature use.

Other viscosities shown in the chart below may be used when the average temperature in the area is within the indicated range.

- A. With the generator level, remove the oil filler cap/dipstick. Wipe the dipstick clean and reinsert it without screwing in.
- B. If the level is low, fill to the upper level with the recommended oil. Do not overfill; excess oil will result in power loss and smoking.

Oil capacity: 2.4 ℓ (2.5 US qt)

OIL FILLER CAP/DIPSTICK

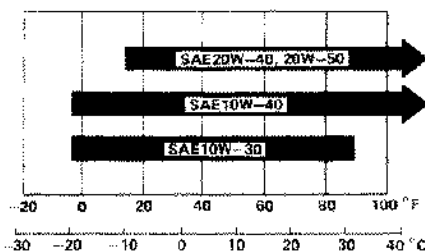
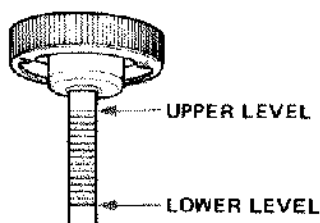
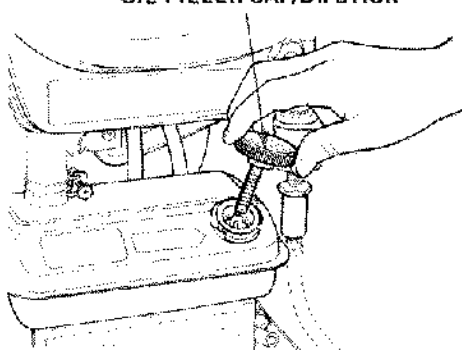



---

**NOTE:** When the oil runs lower than the specified level during operation, the buzzer will sound through an oil alert system to protect the engine from overheating.

If this occurs, add oil up to the upper level.

**CAUTION:** Running the engine with insufficient oil can cause serious engine damage.

2. Check the fuel line, wires, cables and coupler for tightness.

Use clean, fresh, unleaded or regular automobile gasoline with a research octane of 91 or higher or a pump octane ( $\frac{R+M}{2}$ ) of 86 or higher.

Do not use highly leaded premium fuels.

**WARNING**

- Gasoline is extremely flammable and explosive under certain conditions. Refuel in a well ventilated area with the engine stopped.
- Do not smoke or allow open flames or sparks near the fuel line joint or compartment or when gasoline is stored.
- Do not overfill the tank and make sure the filler cap is securely closed after refueling.
- Be careful not to spill fuel when refueling. Fuel vapor or spilled fuel may ignite. If any fuel is spilled, make sure the area is dry before starting the engine.

**NOTES:**

- Using unleaded gasoline results in reduced engine and spark plug deposits and extends the life of exhaust system components.
- If you are considering using an alternate fuel, check with your RV dealer first.

**CAUTION:** Gasoline substitutes are not recommended; they are harmful to the fuel system components.

3. Check that the air cleaner elements are clean and properly installed.
4. Make sure the air inlet and outlet passages are clean and unobstructed.

**CAUTION:** The generator is air-cooled and may be damaged if ventilation is inadequate.

5. Check the battery connections for tightness.  
Connect the battery positive (+) cable to the positive terminal, then connect the negative (-) cable to the ground terminal. When disconnecting the cables from the control box, always remove the negative cable first, and then the positive cable.  
To prevent corrosion, coat the terminals with petroleum grease.

**WARNING:** Batteries produce explosive gases. Keep sparks, flames, and cigarettes away.

**CAUTION:**

- Do not attempt to start the vehicle engine and generator simultaneously.
- Do not reverse polarity by connecting the battery cables to the wrong generator terminals. Serious damage to the generator and/or battery may occur.
- Do not allow the cable ends to touch each other.

6. Check to be sure the generator compartment is clean.

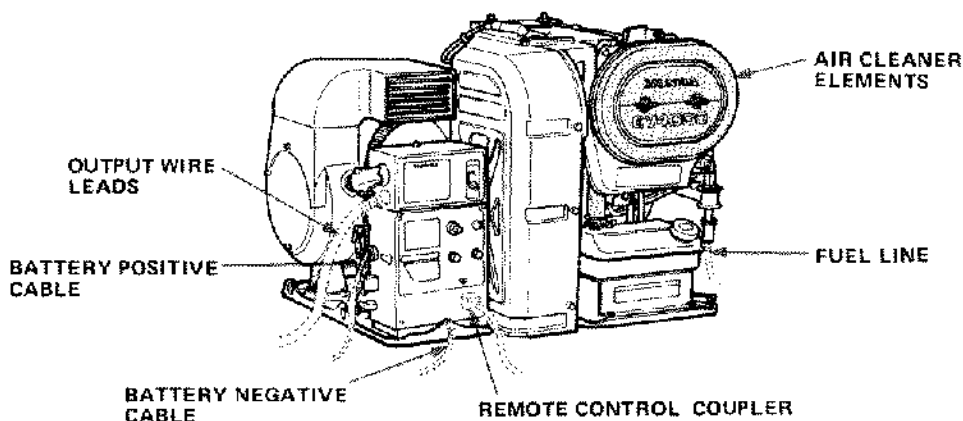

## 4. STARTING AND STOPPING THE ENGINE

---

### Starting the engine

#### NOTES:

- The generator has an automatic choke.
- You can start and stop the EV4000 using either the main switch or the remote control switch.

1. Turn all loads off.
2. Push and hold the engine switch until the engine starts and the pilot light glows steadily.

**CAUTION:** If the engine does not start, do not continue cranking for longer than 15 seconds. Release the engine switch for at least 30 seconds before pushing it again.

#### NOTES:

- If you experience difficulty in starting the engine, turn the circuit breaker OFF and push the switch again. Be sure to switch the breaker ON after the engine starts.
- When the speed of the starter motor drops after a period of time, it is an indication that the battery should be recharged.
- During cranking, the oil alert buzzer may sound because of lack of vacuum in the crankcase. However, this does not mean that the oil is lower than the specified level.

### Stopping the engine

Push and release the engine switch. It is not necessary to hold the switch until the engine stops.

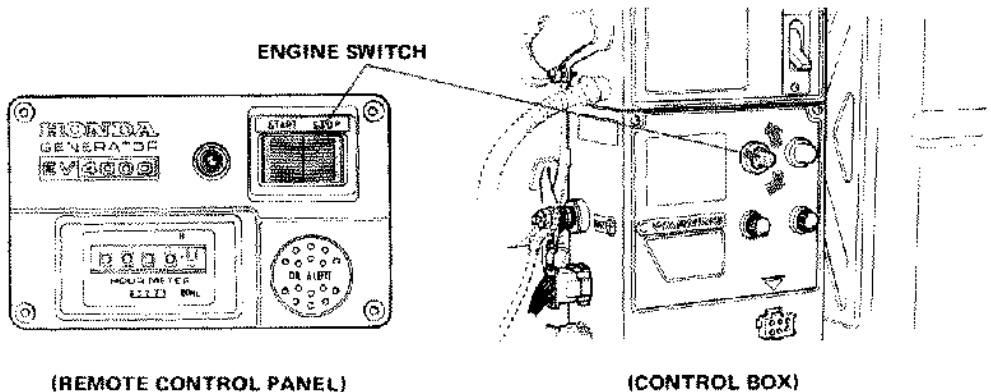

## 5. GENERATOR USE

AC output terminals are located in the upper part of the control box with the circuit breaker. The AC wires terminate either at the RV's junction box, or the generator/outside power switch box (in vehicles that can use outside power).

**CAUTION:** Be sure that appliances do not exceed the rated load. Substantial overloading will switch off the circuit breaker. Lesser overloading will not switch off the circuit breaker and will shorten the service life of the generator.

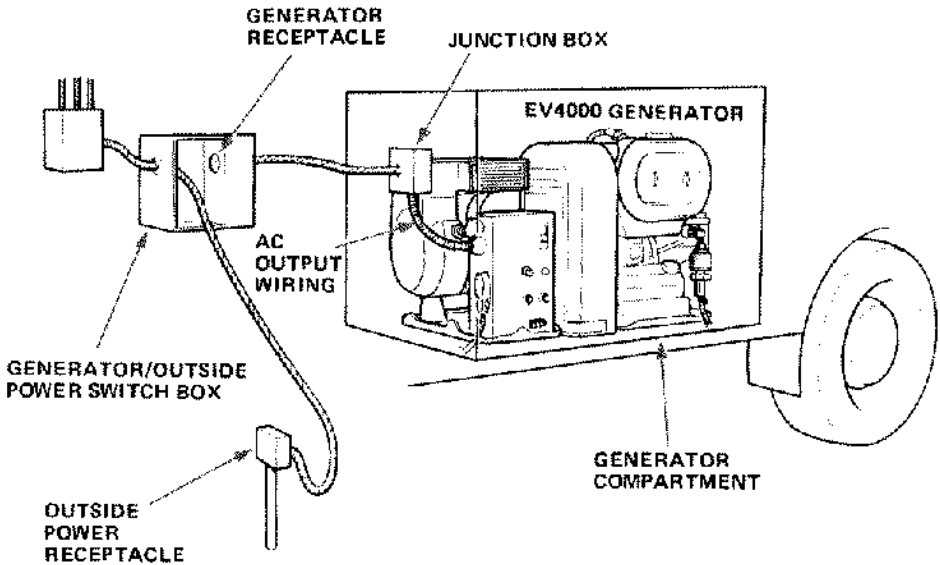

## 6. MAINTENANCE

---

Periodic maintenance and adjustment are essential if high level performance is to be maintained. The required service intervals and the kinds of maintenance to be performed are described on the next page.

### **⚠ WARNING**

- Always allow the generator to cool off before performing any maintenance on the exhaust system. The parts become very hot during operation and remain hot enough to inflict serious burns even after the generator is turned off.
- Since the engine must be run for the general inspection before each use, make sure the area is well ventilated. The exhaust contains poisonous carbon monoxide gas.

**CAUTION:** Use only new genuine HONDA parts or their equivalent. The use of replacement parts which are not of equivalent quality may damage the generator.

## Maintenance Schedule

Items	REGULAR SERVICE PERIOD Perform at every indicated operating hour interval				
	Each use	First 20 Hrs.	Every 100 Hrs.	Every 200 Hrs.	Every 300 Hrs.
General inspection	● (1)				
Engine oil inspection	●				
Engine oil change		●		●	
Air cleaner element cleaning			● (2)		
Air cleaner element replacement				●	
Spark plug maintenance				●	
Spark arrester cleaning			●		
Fuel filter replacement					●
Valve clearance adjustment					● (3)
Combustion chamber and valve cleaning					● (3)
Fuel line check (Replace if necessary)					● (3)
Oil hose check (Replace if necessary)					● (3)

- NOTES: (1) With the engine running, visually and audibly check exhaust system for leaks.  
 (2) Service more frequently when the generator is used in dusty areas.  
 (3) This service should be performed by an authorized Honda dealer unless the owner has the proper tools and is mechanically proficient. See the Honda Shop Manual.

---

## Tool kit

The tools supplied are necessary for spark plug service. Always keep the kit with the generator.

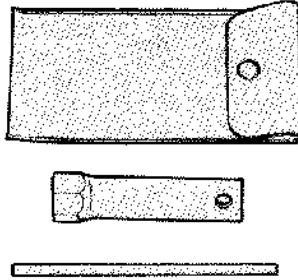

## Changing oil

Drain the oil while the engine is still warm to assure rapid and complete draining.

- Remove the drain bolt and the filler cap/dipstick to drain the oil.
- Check that the sealing washer is in good condition (replace if necessary), then retighten the bolt securely.
- Refill with the recommended oil to the upper level on the dipstick.

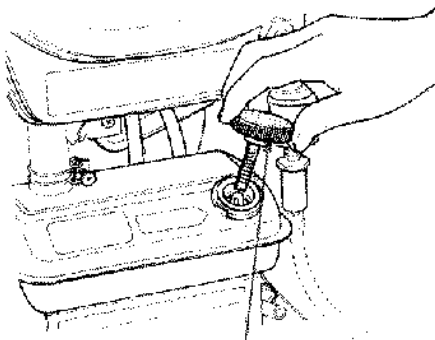

FILLER CAP/DIPSTICK

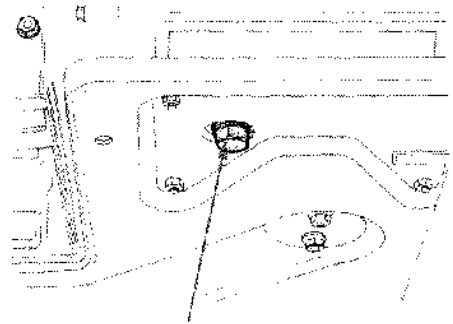

DRAIN BOLT

---

## Air cleaner service

A dirty air cleaner will cause hard starting, misfiring and excessive fuel consumption. Service the air cleaner at regular intervals, more frequently when used in dusty areas.

- a. Remove the wing nuts and the air cleaner cover.  
Remove the elements and separate them.
- b. Clean the foam element by tapping it lightly to remove dust.
- c. Clean the paper element by applying compressed air from inside the element.

If compressed air is not available, tap around the element casing.

**CAUTION:** Never allow the elements to get wet or oily. They may clog and become ineffective.

**WARNING:** Never use gasoline or low flash point solvents for cleaning the air cleaner element. A fire or explosion could result.

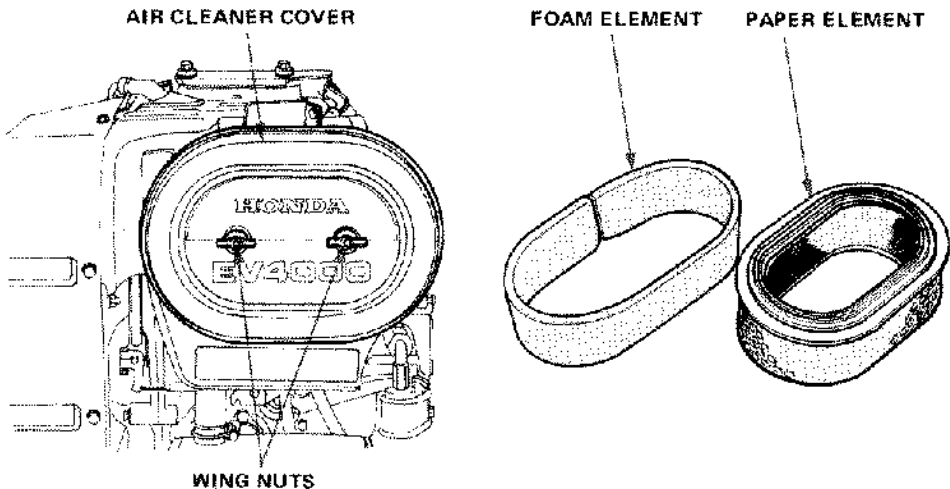



---

## Fuel filter service

The filter prevents dirt which may be in the fuel tank from entering the fuel pump and carburetor.

**WARNING** Gasoline is extremely flammable and explosive under certain conditions. Do not smoke while servicing the filter.

- a. Remove the vehicle fuel cap to relieve pressure in the fuel tank.
- b. Carefully disconnect the fuel line. Keep it vertical and above fuel tank level to minimize leakage.
- c. Unscrew the old filter from the fuel cut-off solenoid valve.
- d. Screw in the new filter and reconnect the fuel line securely.

**WARNING** Check for fuel leaks and make sure the area is dry before starting the engine.

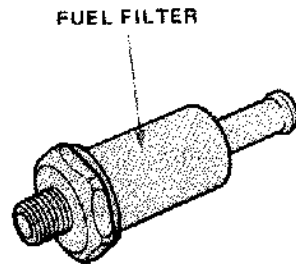
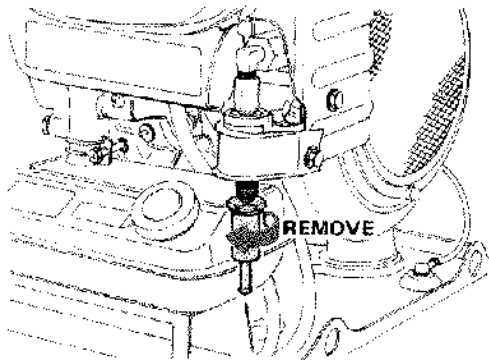

---

## Spark plug service

Recommended spark plug: BPR6HS-10 (NGK) or W20FPR-U10 (ND)

To ensure proper engine operation, the spark plug must be properly gapped and free of deposits.

- a. Clean any dirt from around the spark plug.
- b. Remove the plug cap, and use a spark plug wrench to remove the plug.
- c. Visually inspect the spark plug. Discard it if the insulator is cracked or chipped. The center electrode should have square edges and the side electrode should not be eroded.  
Remove any deposits with a wire brush.
- d. Check the plug gap with a wire-type feeler gauge. The gap should be 0.9 – 1.0 mm (0.035 – 0.039 in). Correct as necessary by bending the side electrode.
- e. Make sure the sealing washer is in good condition, and with the washer attached, thread the plug in by hand to prevent cross-threading.
- f. Tighten a new spark plug 1/2 turn with the wrench to compress the washer. If you are reusing a plug, it should only take 1/8 – 1/4 turn after the plug seats.

### CAUTION:

- The spark plug must be securely tightened. An improperly tightened plug can become very hot and possibly damage the generator.
- Never use a spark plug with an improper heat range.

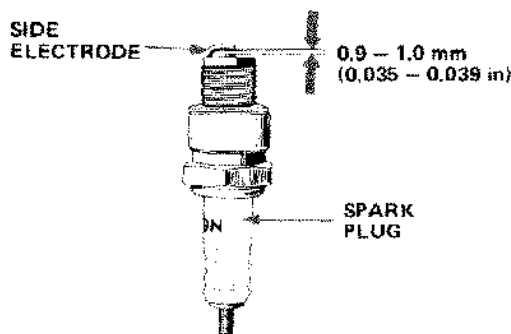

---

## Spark arrester service

**WARNING** If the generator has been running, the muffler will be very hot. Allow it to cool before proceeding or you could be seriously burned.

- Remove two 6 mm bolts and remove the spark arrester.
- Check the muffler exhaust port for carbon deposits. Clean if necessary.
- Clean the spark arrester with a wire brush and tap it to remove deposits from the inside.
- Install the spark arrester in the muffler and tighten the bolts securely.

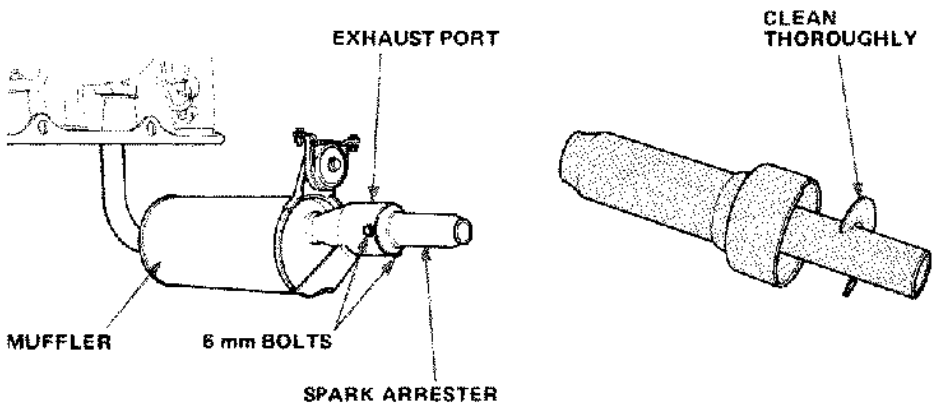

## 7. EXTENDED STORAGE

---

When the generator will be out of service for 30 days or more, careful storage preparation will help to prevent deterioration from non-use.

1. Change the engine oil (page 12).
2. Remove the spark plug and pour about a tablespoon of clean engine oil into the cylinder. Crank the engine for several seconds to distribute the oil, then reinstall the spark plug.
3. Clean the air cleaner elements (page 13).
4. Drain the carburetor by placing the drain tube in a suitable gasoline container and loosening the drain screw. Retighten the screw after draining.
5. Replace the fuel filter (page 14).
6. Make sure the generator compartment is clean and dry.

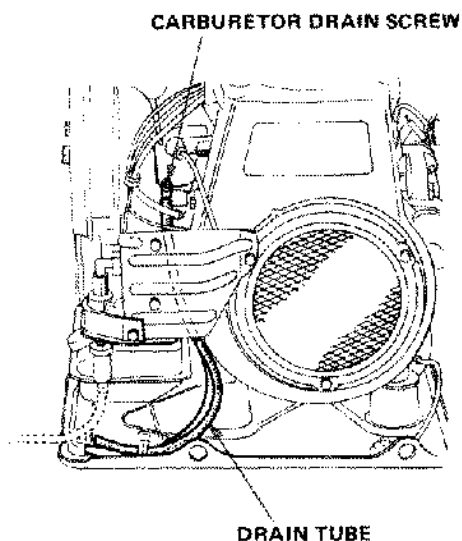

## 8. TROUBLESHOOTING

---

### Difficult starting

- 1) Check the F1 fuse for blowing.
- 2) Turn the circuit breaker OFF.
- 3) Check the fuel level. Some RV vehicles will not continue to supply fuel to the generator after the fuel tank level is below a certain limit.
- 4) Check the battery electrolyte level and condition.
- 5) Check for a dirty air cleaner.
- 6) Check the spark plug condition.
- 7) Check the engine oil level; be sure the oil viscosity is correct.

### No electricity

- 1) Check the F2 fuse for blowing.
- 2) Be sure the circuit breaker is ON.
- 3) Check the electrical appliance or equipment for any defects.

### Fuse replacement

Before replacing a blown fuse, determine the cause and correct the problem. Remove the old fuse by turning the fuse holder counterclockwise. Use only the specified fuse, and be sure to retighten the holders securely.

Specified fuse: 3 A (F1, F2)

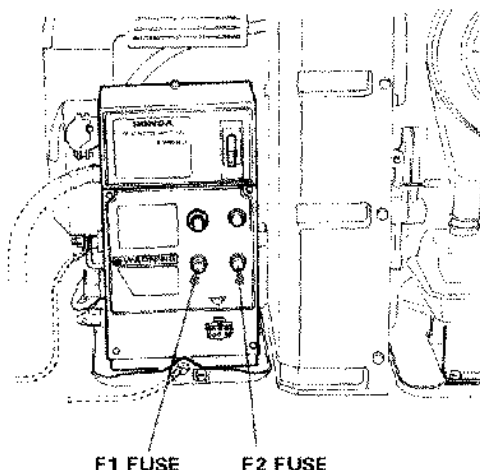

## 9. SPECIFICATIONS

### Dimensions

Length x Width x Height (without muffler)	655 x 460 x 455 mm (25.8 x 18.1 x 17.9 in)
Gross weight	85 kg (187 lb)

### Engine

Model	Honda G400 (With electric starter)
Engine Type	4-Stroke, side valve, 1 cylinder
Displacement [Bore x Stroke]	406 cm <sup>3</sup> (24.8 cu in) [86 x 70 mm (3.39 x 2.76 in)]
Compression Ratio	6.5 : 1
Fuel Consumption	3.75 ℓ (3.96 US qt)/Hr. (at rated load)
Governed engine speed	3,600 rpm
Cooling System	Forced air cooling
Ignition System	CDI (Capacitor Discharge Ignition)
Oil capacity	2.4 ℓ (2.5 US qt)
Spark plug	BPR6HS-10 (NGK) or W20FPR-U10 (ND)

### Generator

Output	4.0 kVA (4,000 W)
Phase	Single
Voltage	115V
Amperage	35 A
Frequency	60 Hz

# 10. WIRING DIAGRAM

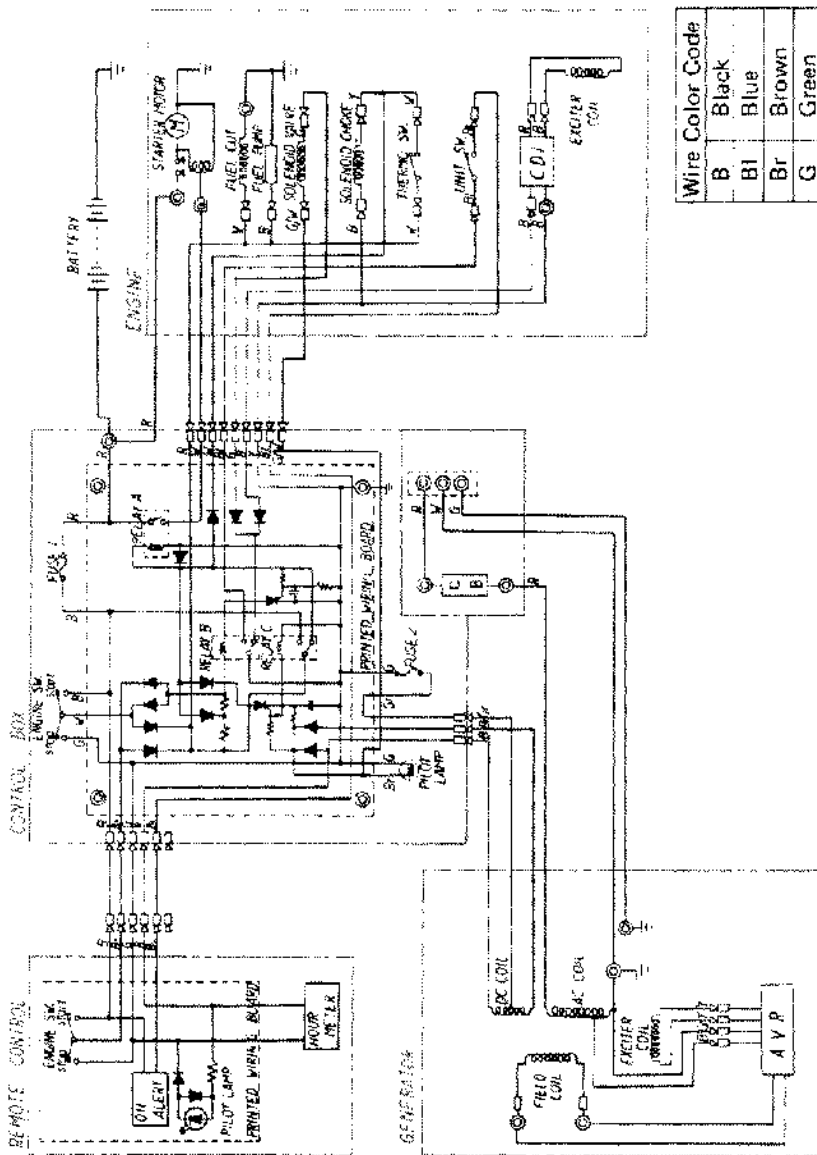

Wire Color Code	Color
B	Black
Bl	Blue
Br	Brown
G	Green
Gr	Gray
R	Red
V	Violet
W	White
Y	Yellow

Part Name	Code
Automatic Voltage Regulator <td>AVR</td>	AVR
Circuit Breaker <td>CB</td>	CB
Capacitor Discharge Ignition <td>CDI</td>	CDI

## 11. MAINTENANCE RECORD

\* Perform the maintenance on page 11 and record the hour meter reading at that time here.

Interval Items Times	Every 100 Hr.	Every 200 Hr.	Every 300 Hr.
	<ul style="list-style-type: none"> <li>• Air cleaner element cleaning</li> <li>• Spark arrester cleaning</li> </ul>	<ul style="list-style-type: none"> <li>• Engine oil change</li> <li>• Air cleaner element replacement</li> <li>• Spark plug maintenance</li> </ul>	<ul style="list-style-type: none"> <li>• Fuel filter replacement</li> <li>• Valve clearance adjustment</li> <li>• Combustion chamber and valve cleaning</li> <li>• Fuel line check</li> <li>• Oil hose check</li> </ul>
1	/ 100 Hr.	/ 200 Hr.	/ 300 Hr.
2	/ 200 Hr.	/ 400 Hr.	/ 600 Hr.
3	/ 300 Hr.	/ 600 Hr.	/ 900 Hr.
4	/ 400 Hr.	/ 800 Hr.	/1200 Hr.
5	/ 500 Hr.	/1000 Hr.	/1500 Hr.
6	/ 600 Hr.	/1200 Hr.	/1800 Hr.
7	/ 700 Hr.	/1400 Hr.	/2100 Hr.
8	/ 800 Hr.	/1600 Hr.	/2400 Hr.
9	/ 900 Hr.	/1800 Hr.	/2700 Hr.
10	/1000 Hr.	/2000 Hr.	/3000 Hr.
11	/1100 Hr.	/2200 Hr.	/3300 Hr.
12	/1200 Hr.	/2400 Hr.	/3600 Hr.
13	/1300 Hr.	/2600 Hr.	/3900 Hr.
14	/1400 Hr.	/2800 Hr.	/4200 Hr.
15	/1500 Hr.	/3000 Hr.	/4500 Hr.
16	/1600 Hr.	/3200 Hr.	/4800 Hr.
17	/1700 Hr.	/3400 Hr.	/5100 Hr.



## Warranty Service

---

### Owner Satisfaction

Your satisfaction and goodwill are important to your dealer and to us. Normally, any problems with the product will be handled by your dealer's service department. Sometimes, however, despite the best intentions of all concerned, misunderstandings can occur. If your problem has not been handled to your satisfaction, we suggest you take the following action:

- Discuss your problem with a member of dealership management. Often complaints can be quickly resolved at that level. If the problem has already been reviewed with the Service Manager, contact the owner of the dealership or the General Manager.
- If your problem still has not been resolved to your satisfaction, contact the Motorcycle and Power Products Customer Relations Department at the regional office of American Honda Motor Co., Inc. in your area. Regional office locations are shown on the following page. We will need the following information in order to assist you:
  - Your name, address, and telephone number
  - Product model and serial number
  - Date of purchase
  - Dealer name and address
  - Nature of the problem

After reviewing all the facts involved, you will be advised of what action can be taken. Please bear in mind that your problem will likely be resolved at the dealership, using the dealer's facilities, equipment, and personnel, so it is very important that your initial contact be with the dealer.

Your purchase of a Honda product is greatly appreciated by both the dealer and American Honda Motor Co., Inc. We want to assist you in every way possible to assure your complete satisfaction with your purchase.

## Regional Office Locations

**NORTHWEST REGIONAL OFFICE**  
(includes Alaska)  
American Honda Motor Co., Inc.  
Motorcycle and Power Products  
Customer Relations Department  
P.O. Box 30285  
Portland, Oregon 97220  
Telephone: (503) 255-1186

**MIDWEST REGIONAL OFFICE**  
American Honda Motor Co., Inc.  
Motorcycle and Power Products  
Customer Relations Department  
P.O. Box 22  
Greendale, Wisconsin 53129  
Telephone: (414) 421-9300

**NORTHEAST REGIONAL OFFICE**  
American Honda Motor Co., Inc.  
Motorcycle and Power Products  
Customer Relations Department  
P.O. Box 748  
Moorestown, New Jersey 08057  
Telephone: (609) 778-1100

**WESTERN REGIONAL OFFICE**  
(includes Hawaii)  
American Honda Motor Co., Inc.  
Motorcycle and Power Products  
Customer Relations Department  
P.O. Box 420  
Gardena, California 90247  
Telephone: (213) 604-2524

**SOUTHWEST REGIONAL OFFICE**  
American Honda Motor Co., Inc.  
Motorcycle and Power Products  
Customer Relations Department  
P.O. Box 6408  
Irving, Texas 75062  
Telephone: (214) 258-6883

**SOUTHEAST REGIONAL OFFICE**  
(includes Puerto Rico)  
American Honda Motor Co., Inc.  
Motorcycle and Power Products  
Customer Relations Department  
6684 Jimmy Carter Boulevard  
Norcross, Georgia 30071  
Telephone: (404) 448-1892

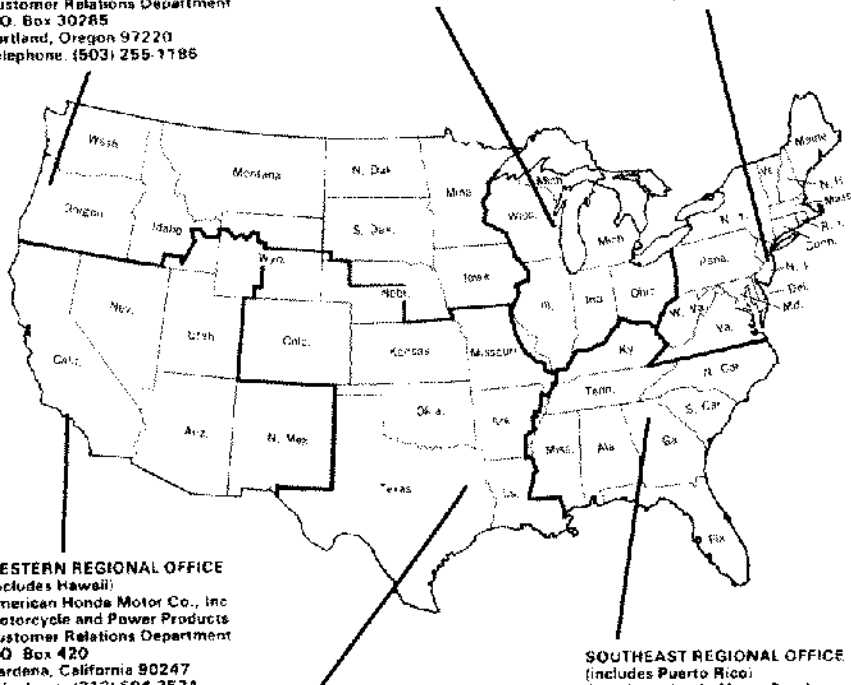

## **Current customer service contact information:**

### **United States, Puerto Rico, and U.S. Virgin Islands:**

Honda Power Equipment dealership personnel are trained professionals. They should be able to answer any question you may have. If you encounter a problem that your dealer does not solve to your satisfaction, please discuss it with the dealership's management. The Service Manager or General Manager can help. Almost all problems are solved in this way.

If you are dissatisfied with the decision made by the dealership's management, contact the Honda Power Equipment Customer Relations Office. You can write:

American Honda Motor Co., Inc.  
Power Equipment Division  
Customer Relations Office  
4900 Marconi Drive  
Alpharetta, GA 30005-8847

Or telephone: (770) 497-6400 M-F, 8:30 am - 5:00 pm EST

When you write or call, please provide the following information:

- Model and serial numbers
- Name of the dealer who sold the Honda power equipment to you
- Name and address of the dealer who services your equipment
- Date of purchase
- Your name, address, and telephone number
- A detailed description of the problem

---

**MEMO**

---

**MEMO**

---

**MEMO**



**HONDA**  
HONDA MOTOR CO., LTD. TOKYO, JAPAN

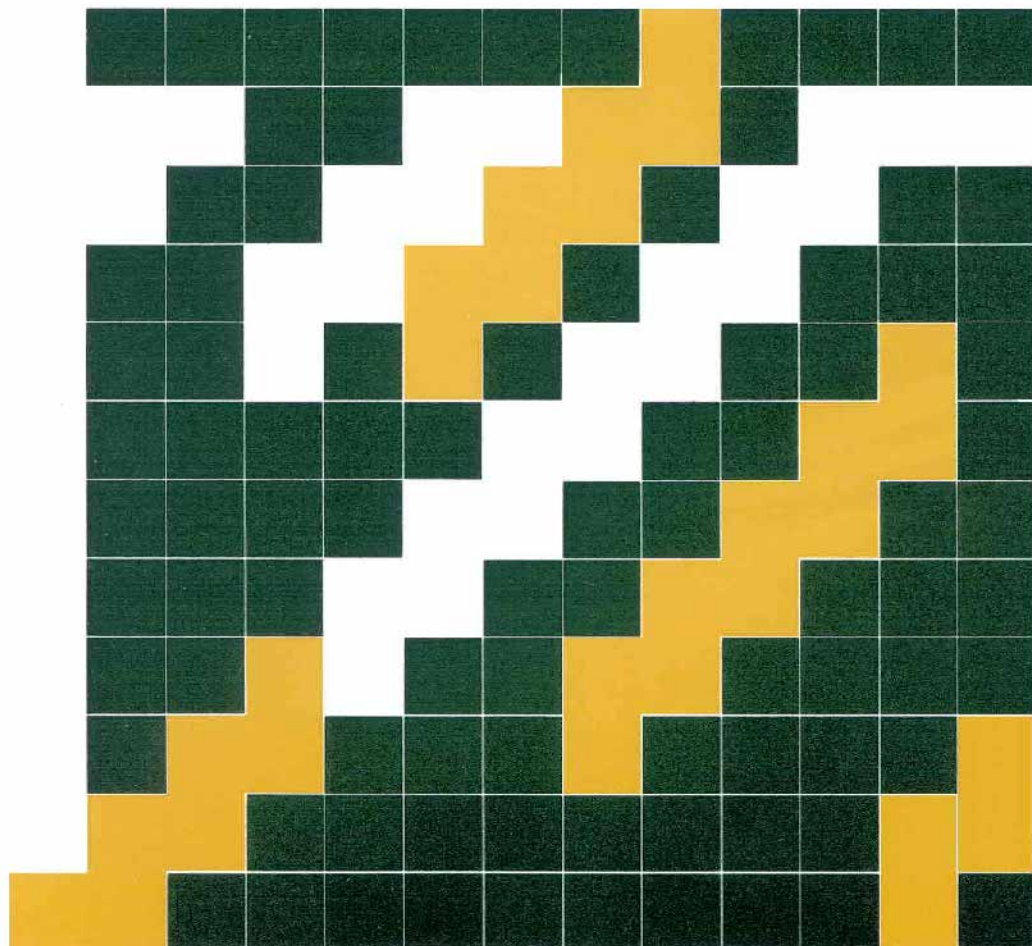

31895000  
00X31-895-0002

(AH) (Y) 8403  
PRINTED IN JAPAN